

Table of Contents

1. Introduction4

2. Operational Specification.....4

2.1 Environment.....4

 2.1.1 Temperature..... 4

 2.1.2 Relative Humidity..... 4

 2.1.3 Altitude..... 4

2.2 Transportation5

 2.2.1 Vibration Test (Package, Non-Operating)..... 5

 2.2.2 Drop Test (Package, Non-Operating) 5

 2.2.3 Vibration Test (Unpackaged, Non-Operating) 6

 2.2.4 HALF-SINE SHOCK..... 6

2.3 Packing Configuration6

 2.3.1 Container Specification..... 6

 2.3.2 Carton Specification 7

 2.3.3 Pallet Specification 8

 2.3.4 Container Carrying Capacity..... 8

2.4 Electrostatic Discharge Requirements.....8

2.5 Safety Requirements.....8

2.6 EMI Requirements8

2.7 Reliability.....9

2.8 Mechanical Design for TCO 03:9

2.9 Environment Protection Design:9

2.10 Acoustical Noise9

3. Input / Output Signal Specification9

3.1 Input Signal Requirements9

 3.1.1 Signal cable (Directly attached to unit) 9

 3.1.2 Video signals:..... 10

 3.1.3 Sync signal:..... 10

3.2 Function11

 3.2.1 Support timing..... 11

3.3 Number of display colors:12

3.4 Adjustment function12

3.5 Power Supply Requirements.....12

 3.5.1 Input Power Requirements 12

 3.5.2 Output Power Requirement 13

Table of Contents

3.5.3 Power Management 13

3.6 Specification of Inverter13

3.7 Panel optical Characteristics14

4. Functional specification16

4.1 Display Quality.....16

4.1.1 Display Data Area (with full white pattern)..... 16

4.1.2 Video Performance 16

4.1.3 Light Output 16

4.1.4 Brightness Adjustment Range..... 16

4.2 Audio Quality16

4.2.1 Preamp + Poweramp: 16

4.2.2 Speaker Driver: 16

4.2.3 Audio Controls: 16

5. Physical Specifications.....17

5.1 Physical Dimension & Appearance17

5.1.1 Overall Dimensions: 17

5.1.2 Outer Appearance: 17

5.2 Construction and Materials on outer surface17

5.3 Base17

5.4 Marking & Labels.....17

5.4.1 Reference Label (Rear panel)..... 17

5.4.2 Controls & Connectors..... 17

5.5 Packaging.....17

5.5.1 Carton Dimension: 17

5.5.2 Shipping Weight: 17

5.5.3 Shipping Container: 17

6. Maintainability Specifications17

6.1 General & Requirements17

6.1.1 Installation: 17

6.1.2 Periodic Maintenance:..... 17

6.1.3 Repair & Calibration: 17

6.2 Mean Time to Repair.....17

6.2.1 Module Level: 17

6.2.2 Component Level: 17

6.3 Accessibility18

6.3.1 General: 18

Table of Contents

6.3.2 Outside Cabinet, access to the following elements 18
6.3.3 Cover Removal, Access 18
6.4 Equipment & Tools Required.....18
6.4.1 Standard Test Equipment..... 18
6.4.2 Documentation 18
6.5 Electrical Emission and Energy Saving summary for TCO 0318
6.5.1 Electrical Field(AC): 18
6.5.2 Magnetic Field(AC): 18
6.5.3 Energy Saving: 18
Appendix 1 – Shipment Conditions.....18
Fig. 1 Physical Dimension Front View and Side view19

1. Introduction

This specification describes a 17.0" color TFT LCD monitor which is supported by analog interface solution and support maximum resolution 1280x1024 at 76 Hz refresh rate. It has the following features:

- User controls:
 - (a) "Power on/off" switch.
 - (b) "Exit" key(Back to main menus or leave OSD menu and hot key of Volume adjustment).
 - (c) "I-key"(For auto adjust vertical position, phase, horizontal position and pixel clock).
 - (d) "Enter" key(For enter sub-menus or select items.).
 - (e) "Left" key (Select left, decreasing adjust and hot key of Contrast adjustment).
 - (f) "Right" key (Select right, increasing adjust and hot key of Brightness adjustment).
 - OSD window for control and information display with 8 languages selection.
 - DPMS (Display Power Management System)
 - Power on/off indicator.
 - Audio speakers supported. (option)
 - High quality advanced zoom function (Scaling function)
 - Tilt base : Attached base with 0~25 degree tilt.
 - DDC2B function supported.
-
- A LCD monitor
 - (a)Head part:
 - (1) A LCD module(AU 170ES05).
 - (2) An AC power and inverter board.
 - (3) An Interface board.
 - (4) A control board.
 - (5) A signal cable with 15pin D-sub connector .
 - (6) Two speakers.

 - (b) Base part:
 - (1)Tilt base. (2)Foldable
 - A power cord
 - An user menu.
 - Setup disk. (including .INF/.ICM/Test pattern) --all INF/ICM/Test pattern are loaded in CD manual + Quick start guide
 - An audio cable.

2. Operational Specification

2.1 Environment

2.1.1 Temperature

- Operating 0 to 40 °C
- Storage -20 to 60 °C

2.1.2 Relative Humidity

- Operating 10 to 90% Max. (non-condensing)
- Storage 10 to 95% Max. (non-condensing)

2.1.3 Altitude

- Operating 0 to 3,048m (10,000ft)
- Storage 0 to 12,192m (40,000ft)

2.2 Transportation

2.2.1 Vibration Test (Package, Non-Operating)

A) Sine-wave vibration for initial resonance sweeps and dwell

* Sine sweep

Frequency (Hz)	Status
5 ~ 26.6	0.6G
26.6 ~ 50	0.016"
50 ~ 500	1.5G

Sweep times: 1 sweep / Per Axis (X,Y, and Z Axis)

* One major resonance dwell is required for each axis.

Total dwell time at each resonance point shall be 15 minutes.

B) Random Vibration

Frequency (Hz)	Slope (dB/Oct.)	Spectrum Level (g2/Hz)
5 ~ 100	0	0.015
100 ~ 200	-6	---
200	---	0.0038

Equivalent to 1.47 G rms

* Duration: 30 Minutes / Per Axis (X,Y, and Z Axis)

Total test time : 90 Minutes

2.2.2 Drop Test (Package, Non-Operating)

A) Drop Height

Weight (Kg)	ACM Spec. Height (cm)
0 – 9	91
> 9 - 18.2	76
> 18.2 - 27.2	61
> 27.2 - 45.4	46
> 45.4 - 68.1	31
> 68.1 – 113.5	26

Upgrade one level of height before MP.

B) Drop Sequence

- Surface
1. Top
 2. Front
 3. Bottom
 4. Rear
 5. Right
 6. Left

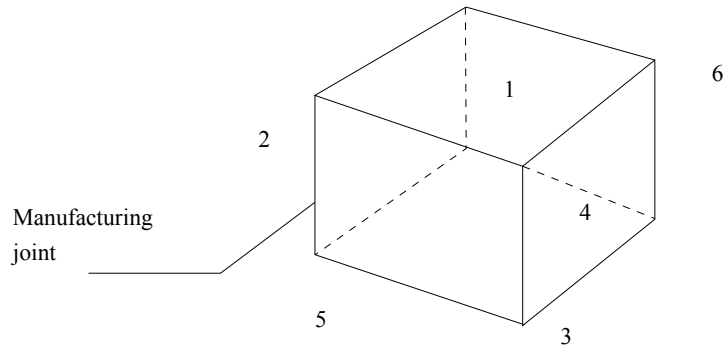

-Corner 5-3-2 select

at weakness side [the low left(or right) corner of the front panel]

- An edge drop with impact on the shortest edge radiating from corner 5-3-2
- An edge drop with impact on the next shortest edge radiating from corner 5-3-2
- An edge drop with impact on the longest edge radiating from corner 5-3-2
- A flat drop with impact on the rear
- A flat drop with impact on the front
- A flat drop with impact on the right
- A flat drop with impact on the left
- A flat drop with impact on the bottom
- A flat drop with impact on the top

After test, there is no electrical and mechanical damage permitted.

2.2.3 Vibration Test (Unpackaged, Non-Operating)

5~200Hz at 1.04g rms

FREQUENCY (Hz)	SPECTRUM LEVEL (g ² /Hz)
2.0	0.0185
4.0	0.0300
8.0	0.0300
40.0	0.0030
55.0	0.0100
70.0	0.0100
200.0	0.0010

- DURATION: 15 MINUTES PER AXIS.

2.2.4 HALF-SINE SHOCK

Test conditions:

- Test unit : 2 sets
- Each unit has to withstand 18 shocks.(3 shocks pre face)
- No- operation
- Half-sine wave
- Duration : 3ms
- Acceleration(G) : 75G

2.3 Packing Configuration

2.3.1 Container Specification

a. Shipping Container

Container Type		20'8'8'6" " Steel	40'8'8'6" Steel	40'8'9'6" High Cube Steel
Weight (Kegs)	Gross	24,000	30,480	30,480
	Tare	2,370	4,000	4,200
	Payload	21,630	26,480	26,280
Interior Measurement (mm)	Length	5,898	12,031	12,031
	Width	2,352	2,352	2,352
	Height	2,394	2,394	2,699
Volume (Cubic Meter)		33.2	67.74	76.4
Door opening (mm)	Width	2,340	2,340	2,340
	Height	2,280	2,280	2,585
Useable Interior Dimension (Deducted pallet (130mm & Operating space 50mm))	Length	5,890	12,000	12,000
	Width	2,330	2,330	2,330
	Height	2,100	2,100	2,405

b. Air Transport

Container Type		Container (1) 125"*96"*96"	Container (2) 125"*96"*118"	Container (3) 125"*88"*64"
Weight (Kegs)	Gross	6,804	6,804	4,627
	Tare	129	129	129
	Payload	6,675	6,675	4,498
Interior Measurement (mm)	Length	3,048	3,048	3,048
	Width	2,260	2,260	2,082
	Height	2,438	2,997	1,625
Volume (Cubic Meter)	17	19	11	

2.3.2 Carton Specification

Product Weight (Kegs)	Net	4.2
	Gross	6.2
Carton Interior Measurement (mm)	Length	406
	Width	418
	Height	139
Carton External Measurement (mm)	Length	423
	Width	456
	Height	146

2.3.3 Pallet Specification

a. Dimension

Transport Type		Pallet A	Pallet B	Pallet C	Pallet D
Shipping Pallet Dimension (mm)	Length	812	812	406	406
	Width	836	1254	836	1254
	Height	115	115	115	115
Air Transport Pallet Dimension (mm)	Length	X	X	X	X
	Width	X	X	X	X
	Height	X	X	X	X

2.3.4 Container Carrying Capacity

a. Shipping Container

Stowing Type		Quantity of products (sets)	Quantity of Products (sets)	Quantity of pallet (sets)
		(Every container)	(Every Pallet)	(Every Container)
with pallet	20'	910	Pallet A: 56	Pallet A: 6
			Pallet B: 84	Pallet B: 6
		Pallet C: 28	Pallet C: 1	
		Pallet D: 42	Pallet D: 1	
	40'	1960	Pallet A: 56	Pallet A: 14
			Pallet B: 84	Pallet B: 14

2.4 Electrostatic Discharge Requirements

The subject product must withstand 8 KV for contact discharge and 15 KV for air discharge of Electrostatic Discharge and meet the acceptance criteria as specified IEC 801-2 .

2.5 Safety Requirements

The display unit complies with the following safety standards and specifications.

- UL compliance....standard for information-processing and business equipment, UL 1950.
- CSA compliance...standard C22.2 No. 950-M89, data processing equipment.
- TUV compliance...EN60950 safety specification-business equipment.
- ISO13406-2 .Ergonomic Requirements of Visual Display.
- Demko...EN60950.
- Nemko...EN60950.
- Semko...EN60950.
- Fimko...EN60950.

2.6 EMI Requirements

1. This display unit complies with the following EMC rules and regulations.

- FCC compliance...FCC Rule, Part 15, Subpart B, Class B.
- VCCI compliance...VCCI Rule, Class-2.
- CE Mark Compliance... 89/336/EEC.
EN55024, EN61000-4-2/-3/-4/-5/-6/-8/-11
EN55022, Class B.
EN61000-3-2,EN61000-3-3.

- DNSF compliance...EN55022, Class B.
- MPR2 compliance
- TCO99
- C-Tick
- BSMI
- EPA

2. The sample for EMI agency approval should be under 4 dB of the limit.
The production pilot run units should be under 3 dB of the limit.
The mass production units should be under 1 dB of the limit.

2.7 Reliability

1. The prediction MTBF of display unit shall be greater than 60,000 hours excluding the lamp.(at 25 °C)
2. Lamp life time : 40,000 hrs typical at which brightness of lamp is 50% compare to that of initial value at 7.0mA and 25°C.

2.8 Mechanical Design for TCO 03:

1) Front Frame Reflectance:

- * diffuse reflectance: $\leq \pm 10\%$
- * Gloss $\leq \pm 2\%$ gloss unit

2) Labeling of plastics:

Plastic weight > 25g shall be marked in accordance with ISO11469

3) Variety of Plastic:

Type of plastic material is synonymous with the term basic polymer used in ISO1043-1. For blends of plastics e.g. PC+ABS, all weight ratios are considered to be the same type of material.

4) Painting of Plastic:

Plastic materials weighing more than 25 grams included in the VDU. Different kinds of adapters are defined as parts of VDU. Printed wiring board laminates and the flat panel itself are excluded.

5) Metallization of Plastic Housing:

- * Metallized name-plates and control knobs are accepted.

6) Plastic components > 25g shall not contain retardants of organically bound chloride or bromide.

2.9 Environment Protection Design:

Product is Per ES 715-c49 Environment Design Guide

2.10 Acoustical Noise

With the display operating, the issue of sound measured is contained within 40 dB/A in the audible field.

3. Input / Output Signal Specification

3.1 Input Signal Requirements

3.1.1 Signal cable (Directly attached to unit)

3.1.1.1 Video Inputs:

(1) DSUB –digital Signal Inputs

15pin D-sub connector is on the captive signal cable for IBM VGA, compatible graphic adapters.

The pin assignment of this connector is described as below:

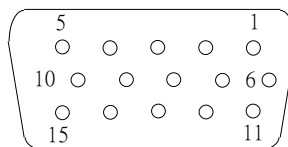

15pin D-sub female

- 1 RED VIDEO
- 2 GREEN VIDEO
- 3 BLUE VIDEO
- 4 GROUND
- 5 Cable Detect
- 6 RED GROUND
- 7 GREEN GROUND
- 8 BLUE GROUND
- 9 PC5V
- 10 SYNC GROUND
- 11 GROUND
- 12 SDA
- 13 H SYNC (H+V)
- 14 V SYNC
- 15 SCL

3.1.1.2 Cable length:

1600mm +/- 20mm

3.1.2 Video signals:

RGB separate, Analog 0.7Vp-p/75 Ohm

3.1.3 Sync signal:

- H/V separate, TTL level
- H/V composite, TTL level

3.2 Function

3.2.1 Support timing

This Interface board is designed to operate in any of the following video mode.

Incoming display mode (Input timing)					Multi-scan operation
Resolution	Horizontal Frequency (KHz)	Vertical Frequency (Hz)	Dot Clock Frequency (MHz)	Remark	Actual display resolution
640x350	31.47(P)	70.08(N)	25.17	DOS	1280x943
720x400	31.47(N)	70.08(P)	28.32	DOS	full screen 1280x1024
640x480	31.47(N)	60.00(N)	25.18	DOS	
640x480	35.00(N)	67.00(N)	30.24	Macintosh	
640x480	37.86(N)	72.80(N)	31.5	VESA	
640x480	37.50(N)	75.00(N)	31.5	VESA	
800x600	37.88(P)	60.32(P)	40.00	VESA	
800x600	48.08(P)	72.19(P)	50.00	VESA	
800x600	46.86(P)	75.00(P)	49.50	VESA	
832X624	49.72(N)	74.55(N)	57.29	Macintosh	
1024x768	48.36(N)	60.00(N)	65.00	VESA	
1024x768	56.48(N)	70.10(N)	75.00	VESA	
1024x768	60.02(P)	75.00(P)	78.75	VESA	
1024X768	60.24(N)	74.93(N)	80.00	Macintosh	
1152x864	67.50(P)	75.00(P)	108.00	VESA	
1152x870	68.68(N)	75.06(N)	100.00	Macintosh	
1152x900	61.80(N)	66.00(N)	94.50	SUN 66	
1152x900	71.81(N)	76.14(N)	108.00	SUN	
1280x1024	64.00(P)	60.00(P)	108.00	VESA	
1280x1024	75.83(N)	71.53(N)	128.00	IBM1	
1280x1024	80.00(P)	75.00(P)	135.00	VESA	
1280x1024	81.18(N)	76.16(N)	135.09	SPARC2	

Notes :

- (1) If the incoming display mode is not supported by this I/F board listed above, the picture can show up or doesn't which is unpredictable, even the picture can display but probably isn't good or clear.
- (2) Some signals from graphics board may not function properly.
- (3) "P", "N" stands for "Positive", "Negative" polarity of incoming HSYNC/VSYNC(input timing).
- (4) OSD will show "No Signal" message on the screen as below to indicate it while no display mode inputs.
- (5) OSD will show "No Cable Connection" message on the screen as below to indicate it while no cable plug in PC.
- (6) OSD will show "Out of Range" message on the screen to indicate it while input display mode meet the following condition
 - (a) The resolution is large than 1280x1024.
 - (b) The resolution is 1280x1024 but it frequency of vertical sync (Fv) is large than 77Hz.
 - (c) The frequency of horizontal sync (Fh) is large than 83KHz.
 - (d) The frequency of vertical sync (Fv) is large than 76Hz.

3.3 Number of display colors:

16M color numbers (With Dithering)

3.4 Adjustment function

Brightness
Contrast
Display position (Vertical , Horizontal)
Phase
Pixel clock
Color gain(Red, Green, Blue)
OSD position (Vertical , Horizontal)
Multi-language selection
OSD time
Volume
Recall function(Color Recall · Recall All)

3.5 Power Supply Requirements

3.5.1 Input Power Requirements

(1) Input Voltage Range

The unit shall meet all the operating requirements with an input voltage range of 90~264 Vac .

(2) Input Current

Maximum Input Current (MAX) 2 Arms	Measuring Range 90Vac ~ 264Vac
---------------------------------------	-----------------------------------

(3) Frequency Range

The unit shall operate within a frequency range of 47Hz to 63Hz.

(4) Inrush Current

Power supply inrush current shall be less than the ratings of its critical components(including Power switch, fuse, rectifiers and surge limiting device) for all conditions of line voltage.

(5) Regulator Efficiency

70% minimum (measuring at 115Vac and full load)
 Power saving mode < 1 Watts at 115vac

3.5.2 Output Power Requirement

The power circuit shall supply DC power outputs as followings:

Output	Nominal	Regulation	Load Current Range
1	5V-panel	±10%	0 ~ 1.0A
2	3.3V-Fix	±5%	0 ~ 1.0A

3.5.3 Power Management

Mode	H/Vsync	Power consumption	LED Color (Status)	Recovery Time
Normal	Both exist	< 50W (with audio)	Blue (Normal)	--
Normal	Both exist	< 40W (without audio)	Blue (Normal)	--
off	None or Only one exist	< 1W, under 115Vac < 2W, under 264Vac	Amber	< 3 sec

3.6 Specification of Inverter

The backlight system is an edge-lighting type with 4 CCFLs (Cold Cathode Fluorescent Tube).
 The characters of dual lamps are shown in the following tables.

ITEM	SYMBOL	MIN	TYP	MAX	Unit	Condition
Lamp Voltage	VL	--	700	860	V	IL=7.0 mA
Lamp Current	IL	13	14	15	mA	Each connector
Inverter Frequency	FL	40	50	80	kHz	
Starting lamp voltage	VS	1700	--	--	V	Tb=0°C
		1200	--	--	V	Ta=25°C
Lamp life time	LT	30,000	40,000	--	Hr	IL = 7.0±0.5mA Continuous Operation Ta=25±5 °C

NOTE: 1.All condition are at 25C ambient unless otherwise specified.

2. Load Panel=“SXGA 17”

3.7 Panel optical Characteristics

Item	Unit	Conditions	Min.	Typ.	Max.
Viewing Angle	[degree]	Horizontal (Right) CR = 10 (Left)	60 60	70 70	-
		Vertical (Up) CR = 10 (Down)	60 60	70 70	-
		Horizontal (Right) CR = 5 (Left)	70 70	80 80	- -
		Vertical (Up) CR = 5 (Down)	70 70	80 80	- -
Contrast ratio		Normal Direction	250	450	-
Response Time (Note 1)	[msec]	Raising Time	-	4	5
		Falling Time	-	12	20
		Raising + Falling	-	16	25
Color / Chromaticity Coordinates (CIE)		Red x	0.61	0.64	0.67
		Red y	0.31	0.34	0.37
		Green x	0.26	0.29	0.32
		Green y	0.58	0.61	0.64
		Blue x	0.11	0.14	0.17
		Blue y	0.04	0.07	0.10
Color Coordinates (CIE) White		White x	0.28	0.31	0.34
		White y	0.30	0.33	0.36
White Luminance @ CCFL 7.0mA (center)	[cd/m ²]		200	260	-
Luminance Uniformity (Note 2)	[%]		75	80	-
Crosstalk (in 75Hz) (Note 3)	[%]				1.5

Note :

1. Viewing Angle, Contrast Ratio, Response Time, Reflectance, and Chromaticity are measured at panel center.
2. Viewing Angle (θ , ϕ)

Measurement is done on position 1.

Viewing angle origine is the axis normal to the flat panel. Left (L) and Right (R) value are the maximum angles for which CR=10. Up (U) and (D) value are the maximum angles for which CR=10. See figure below

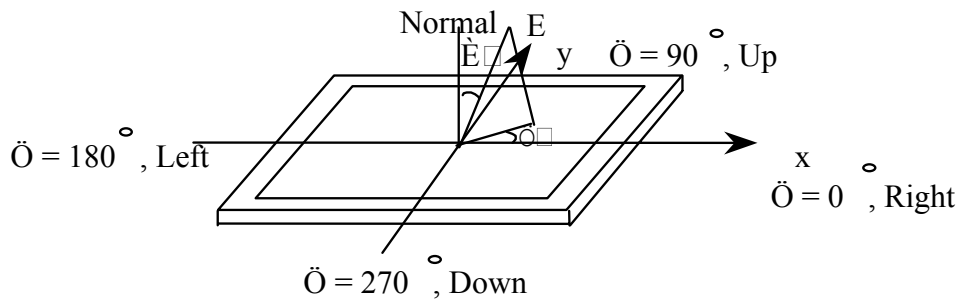

3. Contrast Ratio (CR) is defined mathematically as:

$$\frac{\text{Luminance in White Level (Max.)}}{\text{Luminance in Black Level (Min.)}}$$

(at $\theta = 0^\circ, \phi = 0^\circ$)

4. Response time

TrR measures the transition time of L1 relative luminance from white to black state, from 90% to 10% (see graph below)
 TrD measures the transition time of L1 relative luminance from black to white state, from 10% to 90% (see graph below)

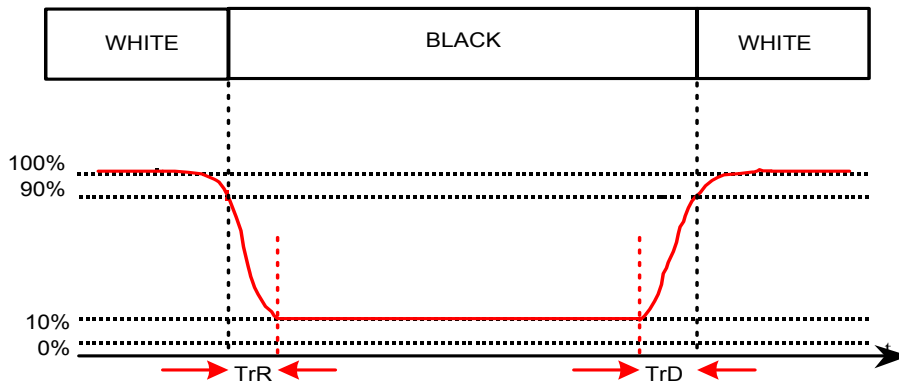

5. Cross talk shall be measured between two patterns.

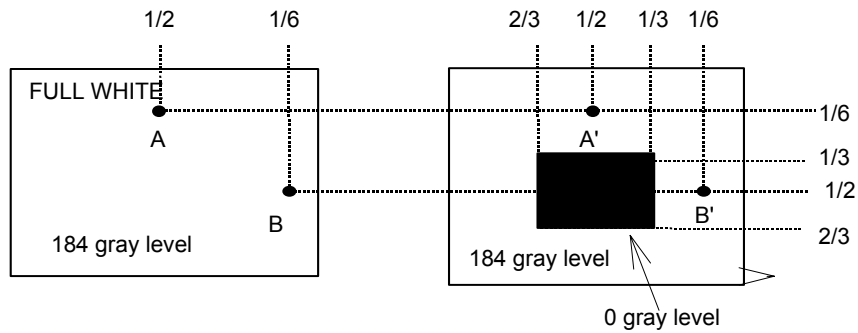

$$|L_A - L_{A'}| / L_A \times 100\% = 1.2\% \text{ max.}, L_A \text{ and } L_B \text{ are brightness at location A and B}$$

$$|L_B - L_{B'}| / L_B \times 100\% = 1.2\% \text{ max.}, L_{A'} \text{ and } L_{B'} \text{ are brightness at location A' and B'}$$

- LA : Luminance of measured point in A (cd/m2)
- LB : Luminance of measured point in B (cd/m2)
- LA' : Luminance of measured point in A' (cd/m2)
- LB' : Luminance of measured point in B' (cd/m2)

(at Viewing Angle $\theta = 0^\circ, \varphi = 0^\circ$)

6. Brightness Uniformity of these 9 points is defined as below:

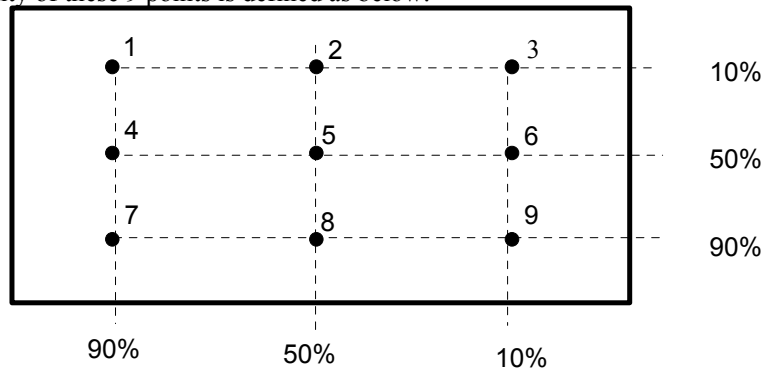

Brightness Uniformity = Min. brightness / Max. brightness x 100 % > 70%

4. Functional specification

All the tests to verify specifications in this section must be performed under the following standard conditions unless otherwise noted. The standard conditions are:

- Temperature : 0 to 40 degree Celsius
- AC line input voltage : 90 Vac to 264 Vac, 47Hz or 63Hz
- Warm-up time : 30 minutes minimum

4.1 Display Quality

4.1.1 Display Data Area (with full white pattern)

- (1) Horizontal: 337.920 mm
- (2) Vertical: 270.336 mm

4.1.2 Video Performance

- (1) Resolution : 1280 X 1024 pixels Maximum
- (2) Contrast ratio : 250(Min.), 450(Typ.)
- (3) Response time : 16 mS(Typ.)
- (4) Viewing angle : Up:70° Down:70° R/L:70° (At contrast ratio >= 10)
- (5) CIE Coordinate: White (0.31, 0.33) +/- (0.03, 0.03) (at user mode)
- (6) Display color: 18 bits color

4.1.3 Light Output

Brightness rating : 260cd/m²(Typ.) @7.0mA

4.1.4 Brightness Adjustment Range

At contrast ratio control set at maximum level, adjusting Brightness control from minimum to maximum position, the light output of WHITE pattern shall be increased more than 40cd/m².

4.2 Audio Quality

4.2.1 Preamp + Poweramp:

- (1) Output Power : 1.0 W rms/CH @ 1KHz,1Vp-p
- (2) THD (@ 1W) : <10%
- (3) S/N ratio : 50db

4.2.2 Speaker Driver:

- (1) Nominal Impedance: 8 Ohm
- (2) Maximum Input Power: 2 W/CH
- (3) Frequency Response: 12KHz
- (4) Size: 40*28.5 mm
- (5) Magnetic Shield: Required

4.2.3 Audio Controls:

- (1) Volume 0- 100 levels

5. Physical Specifications

5.1 Physical Dimension & Appearance

5.1.1 Overall Dimensions:

375mm (W) X 370mm (H) X 155mm (D)

5.1.2 Outer Appearance:

see Fig.1

5.2 Construction and Materials on outer surface

(1) Materials: Plastic

(2) Color: To be defined for Model

5.3 Base

(1)Tilt: first hinge:0°~ 25°

5.4 Marking & Labels

5.4.1 Reference Label (Rear panel)

(1) Reference numbers

(2) Manufacture data

(3) Agency Approvals

(4) Power Ratings

5.4.2 Controls & Connectors

(1) AC power cord input: abbreviated labels

(2) User's Controls: standard print

5.5 Packaging

5.5.1 Carton Dimension:

456mm (W) X423mm (D) X 146mm (H) (LCD monitor)

5.5.2 Shipping Weight:

5.8kg (LCD monitor)

5.5.3 Shipping Container:

1960 sets per 40 feet container with pallet.

6. Maintainability Specifications

6.1 General & Requirements

6.1.1 Installation:

From outside of unit with standard tools and documentation provided to user.

6.1.2 Periodic Maintenance:

No periodic maintenance is required.

6.1.3 Repair & Calibration:

Require spare modules or components as specified as followings:

(1) Interface board ASSY

(2) AC-DC converter board ASSY

(3) Control board ASSY

6.2 Mean Time to Repair

6.2.1 Module Level:

Less than 10 minutes

6.2.2 Component Level:

Less than 15 minutes

6.3 Accessibility

6.3.1 General:

All panels, covers, and major assemblies are removable without disruption of permanent mounting or fasteners.

6.3.2 Outside Cabinet, access to the following elements

- Operating Controls
- AC Inlet
- Audio in

6.3.3 Cover Removal, Access

All sub assemblies and internally adjustable components may be accessed by removing the base and the rear cover .

6.4 Equipment & Tools Required

6.4.1 Standard Test Equipment

- (1) Voltmeter
- (2) Dual trace oscilloscope
- (3) Hand tools as required
- (4) Computer with IBM VGA , or compatible graphic adapter

6.4.2 Documentation

A service manual will be available which covers all service requirements. A users manual written in Japanese German, Italian, Spanish, France and English will be available to ship with the product.

6.5 Electrical Emission and Energy Saving summary for TCO03

6.5.1 Electrical Field(AC):

*Band I< 10V/m (132cd/m², ”+” pattern)

*Band II< 1V/m (132cd/m², ”+” pattern)

Note: Shielded power cord is not acceptable

6.5.2 Magnetic Field(AC):

*Band I< 200nt (132cd/m², ”+” pattern)

*Band II< 32nt (132cd/m², ”+” pattern)

Note: Shielded power cord is not acceptable

6.5.3 Energy Saving:

*1st stage:<15W(recover time:3 sec)

2nd stage:<5W

*single stage:<5W(recover time: 3sec)

Appendix 1 – Shipment Conditions

ITEM	State
Power	ON
Brightness	90
Contrast	50
OSD- Timeout	10s
OSD-Language	English
OSD-Image size	Full Screen
OSD-Color temp	CU MODE

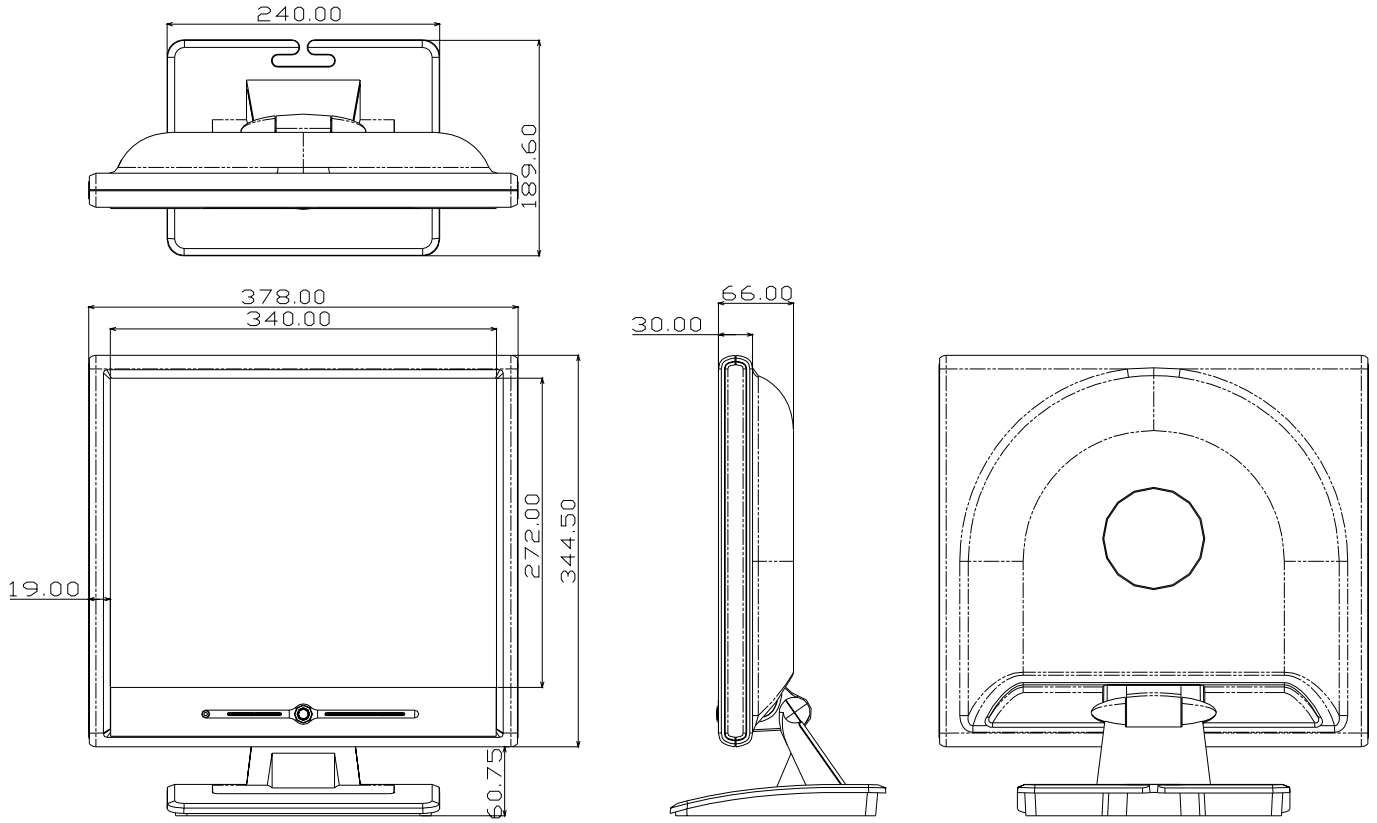

Fig. 1 Physical Dimension Front View and Side view