

Hall-effect rotational-speed sensors

Digital measurement of rotational speeds

712-0667/0679

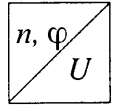

- Versatile signal source with non-contact (proximity) measurement of angles, positions and rotational speeds
- Exact and reliable measurement method with digital output signal
- Insensitive to dirt

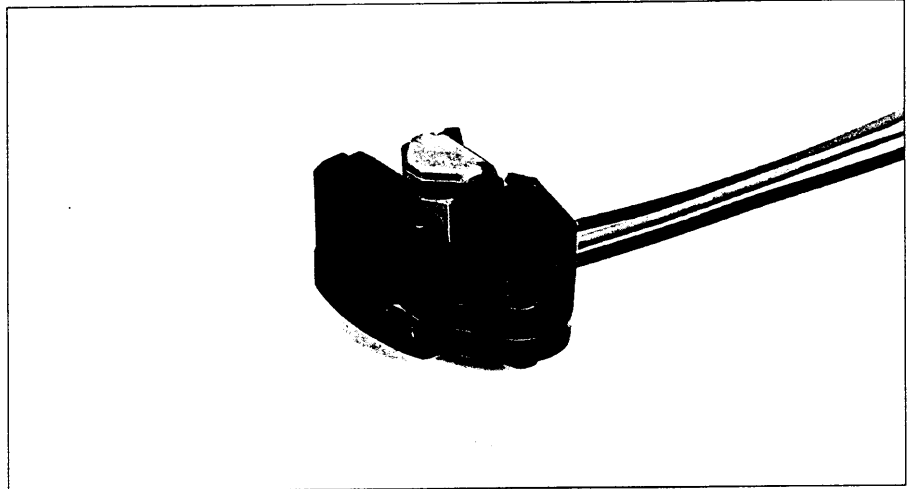

Application

Hall-effect rotational-speed sensors are suitable for non-contacting and thus wear-free measurement of even extremely low rotational speeds. They can also be used for measuring angles and displacement. In such cases, the output signal is independent of the relative speed between the Hall generator itself and the moving trigger-wheel which passes through a gap in the sensor assembly.

The ignition timing of modern motor-vehicle engines is controlled by a non-contacting (breakerless) closed-loop control system which utilizes the position of the camshaft as its reference. A trigger wheel with a vane structure turns in the sensor's magnetic field, whereby the Hall-IC distinguishes – depending on the position of the vane – between the conditions magnetic field “blocked out” (circuit “off”) and “non-blockage” (circuit “on”).

It is thus possible to draw rough conclusions about the angular position of the vane and the rotational speed.

Further applications include the incremental measurement of rotation and displacement without recognition of direction by way of pulse summation. Pure limit-value and full-scale position measurements for moving systems (working cylinders etc.) can likewise be performed, and it is possible to have a relatively large tolerance at right angles to the measurement direction.

Technical data / Range

Part No.	● 1 231 324 224		1 231 324 294	
Supply voltage U_V	-40 ... +80 °C	V	5 ... 20	4.5 ... 30
in temperature range	-40 ... +150 °C	V	6 ... 16	4.5 ... 24
Supply current at $U_V = 16$ V		mA	≤ 13	≤ 21
Output voltage at $U_V = 20$ V			0 ... U_V	0 ... U_V
Output current		mA	0 ... 20 (max.)	0 ... 20
Output saturation voltage		V	≤ 0.4	≤ 0.4
Switch-on and switch-off time of output voltage between 10 % and 90 %		μs	≤ 1.5	9
Sustained temperature		°C	- 40 ... +130	- 40 ... +130
Short-term limit temperatures		°C	- 40 ... +150	- 40 ... +150
Vane specifications				
Min. vane width a				7.6 mm
Min. vane gap				9.8 mm
Vane gap for min. ≥ 12 mm				9.48 mm
Vane thickness, min.				0.75 mm
max.				1.5 mm
Min. vane height				≥ 7.5 mm
Distance between vane and base plate in air gap			min.	4.6 mm
			max.	9.1 mm
Min. distance between vane and Hall-IC				0.01 mm
Min. distance between vane and magnet				0.01 mm
Material: Ferromagnetic, e.g. cold-rolled steel as per DIN 1624				
Electrical connections *				
Positive supply voltage				Red lead
Output voltage (open collector)				Green lead
Pay attention to ground (-) polarity				Black lead

Hall effect

d Thickness of the semiconductor wafer.

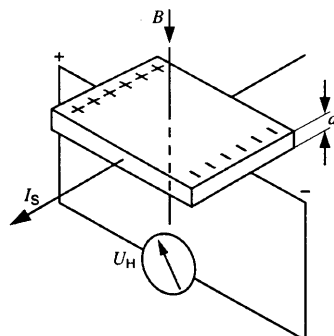

Hall pulse generator

1 Vane with width a , 2 Soft-magnetic conductive elements with permanent magnet, 3 Hall-IC, 4 Air gap.

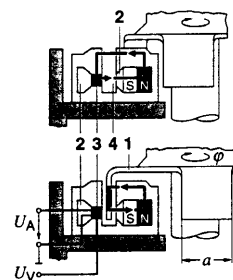

* Caution: Interchanging the connections can lead to sensor destruction.

Dimension drawings

1 231 324 224

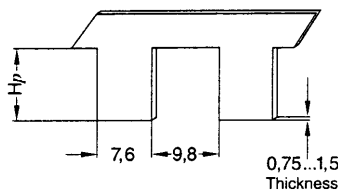
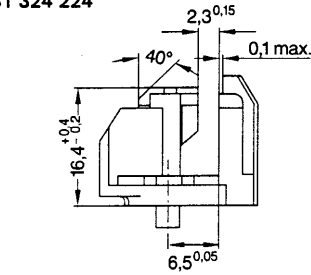

1 231 324 294

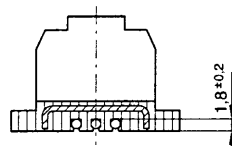
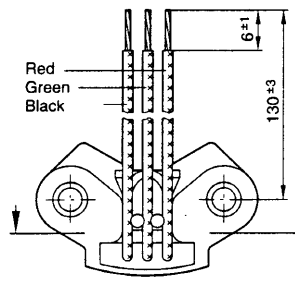
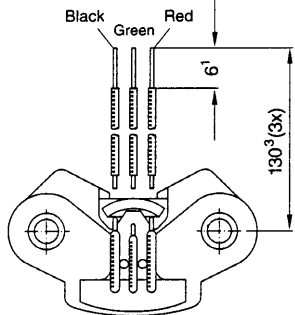
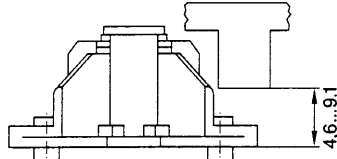
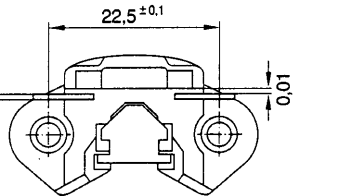
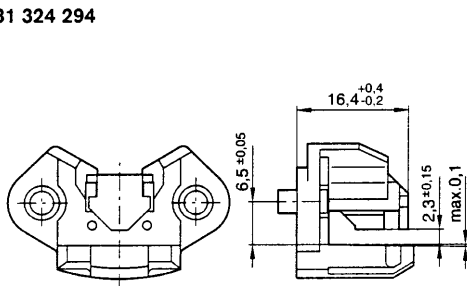

Design and function

Passing a current I_S through a semiconductor wafer produces the Hall voltage U_H at right angles to the direction of the current. The magnitude of this voltage is proportional to the magnetic induction B perpendicular to I_S and the current I_S . The Hall voltage can be influenced by changing the magnetic induction. Since the Hall voltages which can be obtained are very small, they must be amplified. If use is made of silicon Hall-effect elements, the signal-conditioning circuit (e.g. Schmitt trigger followed by driver) is directly integrated onto the same chip. Such a device is known as a Hall-IC. The output takes the form of a transistor with open collector, which performs a switching function. The Hall sensor (Hall-effect vane switch) features a permanent magnet, the lines of force of which pass through magnetic conductive elements, an air gap and the Hall IC.

If a ferromagnetic material (e.g. the vane of an iron trigger wheel) is passed through the the vane-switch air gap, the magnetic flux is diverted through the vane. The Hall-IC switches to "off" when this occurs, as the flux density at the Hall sensor drops virtually to zero. If, on the other hand, there is no vane in the air gap to divert the flux, the magnetic field can permeate the Hall-IC and it switches to "on".

A circular vane structure is required for measuring angles and rotational speeds, whereas displacement measurement necessitates a linear vane structure.

Wiring diagram. Hall pulse generator.

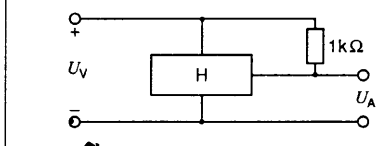

Characteristic curves

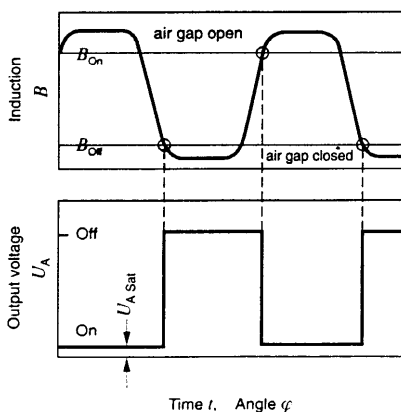

Hall pulse generator (top view)

1 Vane with width a , 2 Magnetically soft conductive elements with permanent magnet, 3 Hall-IC, 4 Air gap.

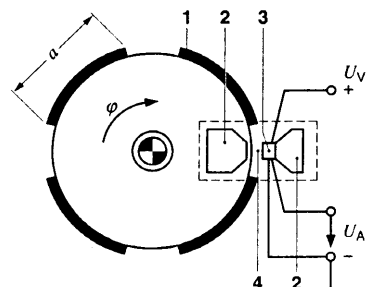

Explanation of symbols:

- B Magnetic induction (through Hall-effect element)
- $B \geq B_{On}$ Magnetic induction, air gap "open" state
- $B \leq B_{Off}$ Magnetic induction, air gap "closed" state
- I_S Sensor current
- U_H Hall voltage
- U_A Output voltage
- U_{Asat} Output saturation voltage
- U_V Supply voltage
- a Vane width
- t Time
- φ Angle