

TEMPERATURE SENSORS

Purpose and Function

Temperature sensors used in modern engine management systems are of NTC [negative temperature co-efficient] design. Simply as temperature rises the resistance of the NTC element reduces. These sensors are used for their logarithmic resistance characteristics as well broad sensitivity range.

These sensors are designed for use in a broad range of purposes and applications involving temperature measurement of water or oil.

Air temperature can be measured with sensor number 0 280 130 085.

For more detailed information about these products refer to our website

www.bosch.com.au



TEMPERATURE SENSOR TECHNICAL DATA

Part Number	Measurement Range	Characteristic Curve	Max Circuit Current [A]	Thread Size	Connector	Figure	Comment
0 280 130 023	- 40 to + 130	A	1.0	M12 x 1.5	9 122 067 011	A	For fuel, oil and water measurement
0 280 130 026	- 40 to + 130	A	1.0	M12 x 1.5	9 122 067 011	A	For fuel, oil and water measurement
0 280 130 032	- 40 to + 130	A	1.0	M12 x 1.5	9 122 067 011	A	Dual Element - water measurement
0 280 130 039	- 40 to + 130	A	1.0	M12 x 1.5	9 122 067 011	A	For air temperature measurement
0 280 130 085	- 40 to + 130	B	1.0	---	9 122 067 011	B	For air temperature measurement

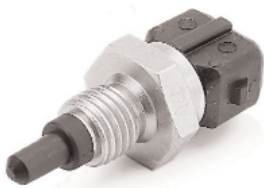

Fig. A

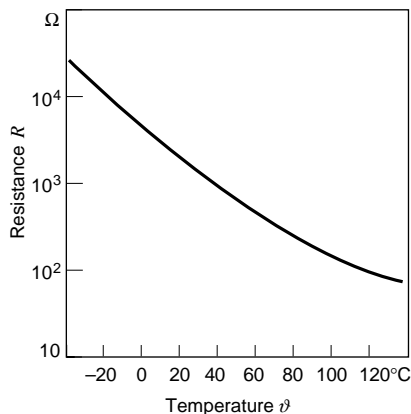
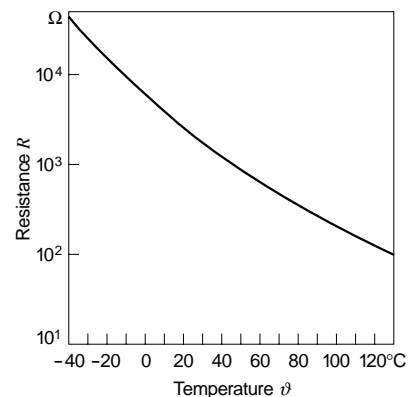
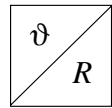

Fig. B



NTC temperature sensors

Measurement of air temperatures between -40 °C and $+130\text{ °C}$



- Measurement with temperature-dependent resistors.
- Broad temperature range.

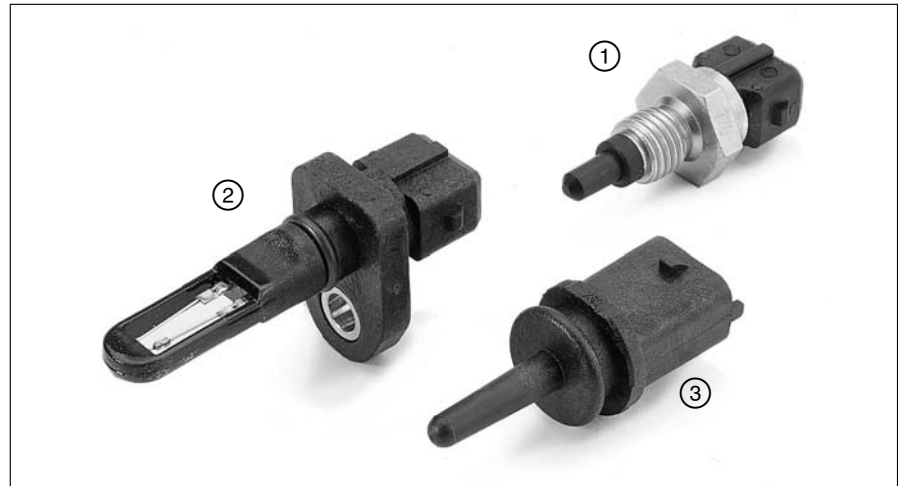

Range

NTC temperature sensor

NTC resistor in plastic sheath

Steel housing
Screw fastening **0 280 130 039**

Polyamide housing
Plug-in mounting **0 280 130 092**
Plug-in mounting **0 280 130 085**

Accessories

For **0 280 130 039**; .. **085**
Connector **1 237 000 036**

Designation	For cable cross-section	Part number
Plug housing	–	1 928 403 137
Contact pins	0.5...1.0 mm ²	1 987 280 103
Individual gaskets	0.5...1.0 mm ²	1 987 280 106
	1.5...2.5 mm ²	1 987 280 107

Note

Each 2-pole plug requires 1 plug housing, 2 contact pins, and 2 individual gaskets. For automotive applications, original AMP crimping tools must be used.

Explanation of symbols:

R Resistance
 ϑ Temperature

Temperature sensor (principle).

- 1 Electrical connection
2 Housing
3 NTC resistor

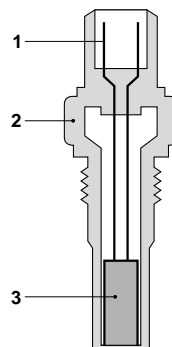

Block diagram.

Technical data

Part number	0 280 130 039	0 280 130 085	0 280 130 092
Illustration	1	2	3
Characteristic curve	1	2	1
Measuring range	°C $-40...+130$	$-40...+130$	$-40...+130$
Permissible temp., max.	°C $+130$	$+140$	$+130$
Electrical resistance at 20 °C	$\text{k}\Omega$ $2.5 \pm 5\%$	$2.4 \pm 5.4\%$	$2.5 \pm 5\%$
Electrical resistance at -10 °C	$\text{k}\Omega$ $8.26...10.56$	–	$8.727...10.067$
	$+20\text{ °C}$ $\text{k}\Omega$ $2.28...2.72$	$2.290...2.551$	$2.375...2.625$
	$+80\text{ °C}$ $\text{k}\Omega$ $0.290...0.364$	–	–
Nominal voltage	V ≤ 5	≤ 5	≤ 5
Measured current, max.	mA 1	1	1
Self-heating at max. permissible power loss			
$P = 2\text{ mW}$ and stationary air (23 °C)	K ≤ 2	–	≤ 2
Thermal time constant ¹⁾	s $\text{ca. } 20$	≤ 5 ²⁾	44
Guide value for permissible vibration acceleration (sinusoidal vibration)	$\text{m} \cdot \text{s}^{-2}$ 100	100	≤ 300
Corrosion-tested as per	DIN 50 018	DIN 50 018	DIN 50 018

¹⁾ At 20 °C . Time required to reach 63% of final value for difference in resistance, given an abrupt increase in air temperature; air pressure 1000 mbar; air-flow rate $6\text{ m} \cdot \text{s}^{-1}$.

³⁾ Time constant τ_{63} in air for a temperature jump of -80 °C to $+20\text{ °C}$ at an air-flow rate of $\geq 6\text{ m} \cdot \text{s}^{-1}$.

Dimension drawings.

0 280 130 039 ①
SW A/F size

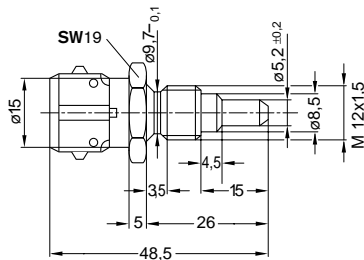

0 280 130 085 ②
B Mounting screw
X Thread in contact area
L Air flow

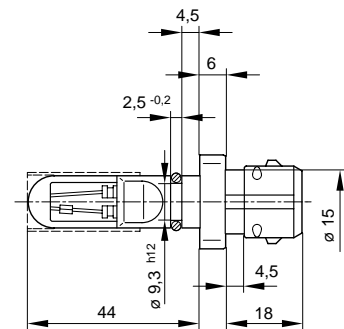
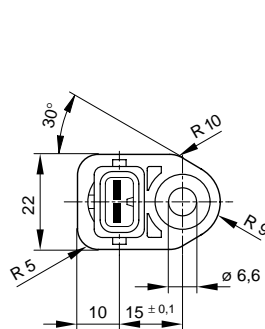

0 280 130 092 ③

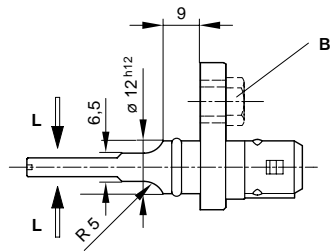
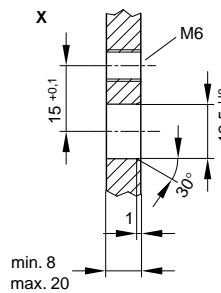
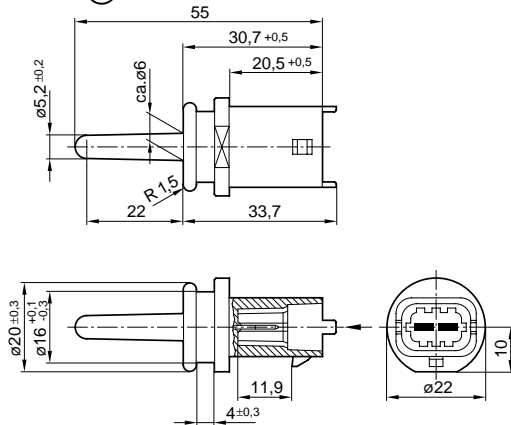

Characteristic curve 1.

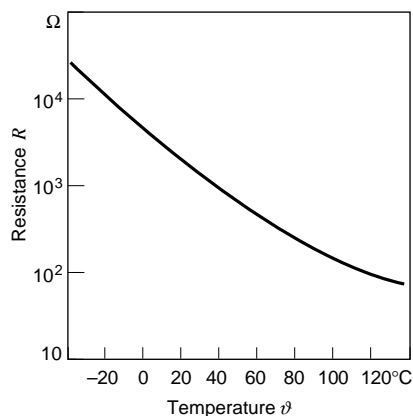

Characteristic curve 2.

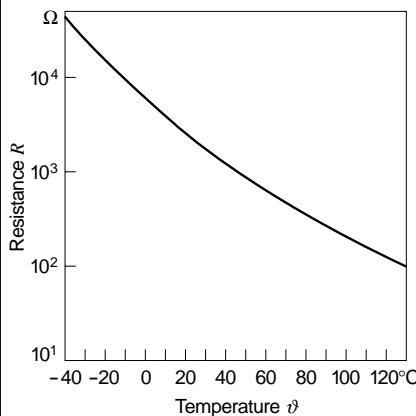

Design and function

NTC sensor:

The sensing element of an NTC temperature sensor (NTC = **N**egative **T**emperature **C**oefficient), is a resistor comprised of metal oxides and oxidized mixed crystals. This mixture is produced by sintering and pressing with the addition of binding agents. For automotive applications, NTC resistors are enclosed in a protective sheath.

If NTC resistors are exposed to external heat, their resistance drops drastically and, provided the supply voltage remains constant, their input current climbs rapidly. This property can be utilised for temperature measurement. NTC resistors are suitable for an extremely wide range of ambient conditions, and with them it is possible to measure a wide range of temperatures.

Installation instructions

Installation is to be such that the front part of the sensing element is directly exposed to the air flow.

NTC temperature sensors

Measurement of liquid temperatures from -40 °C to $+130\text{ °C}$

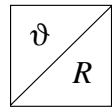

● For a wide variety of liquid-temperature measurements using temperature-dependent resistors.



NTC temperature sensor

Plastic-sheathed NTC resistor in a brass housing

Design and function

NTC sensor:

The sensing element of the NTC temperature sensor (NTC = **N**egative **T**emperature **C**oefficient) is a resistor comprised of metal oxides and oxidized mixed crystals. This mixture is produced by sintering and press-ing with the addition of binding agents.

For automotive applications, NTC resistors are enclosed in a protective housing. If NTC resistors are exposed to external heat, their resistance drops drastically and, provided the supply voltage remains constant, their input current climbs rapidly. This property can be utilised for temperature measurement. NTC resistors are suitable for use in the most varied ambient conditions, and with them it is possible to measure a wide range of liquid temperatures.

Note

Each 2-pole plug requires 1 plug housing, 2 contact pins, and 2 individual gaskets. For automotive applications, original AMP crimping tools must be used.

Explanation of symbols

R Resistance
 ϑ Temperature

Temperature sensor (principle)

- 1 Electrical connection
- 2 Housing
- 3 NTC resistor

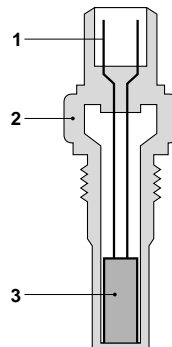
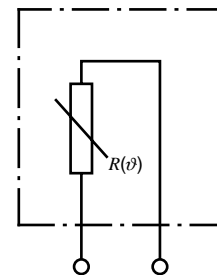
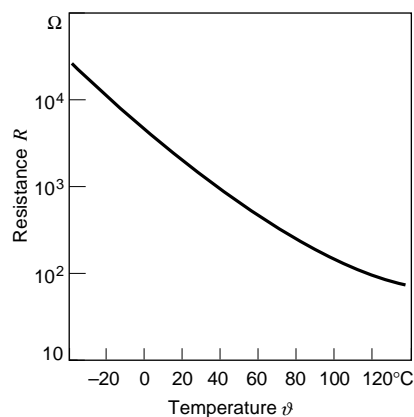

Diagram.



Characteristic curve.



Dimension drawing.

S Plug
F Blade terminal
SW A/F size

0 280 130 026

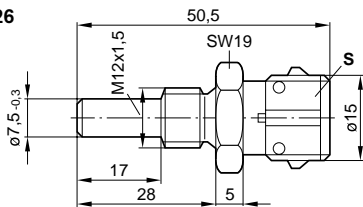

0 281 002 209

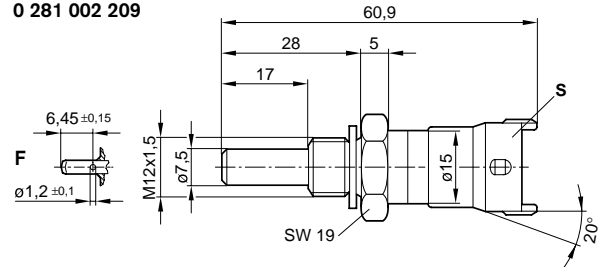

**0 280 130 093,
0 281 002 170**

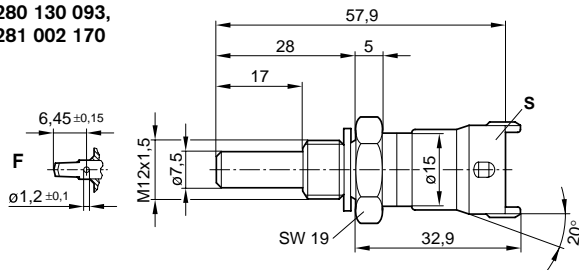

0 281 002 412

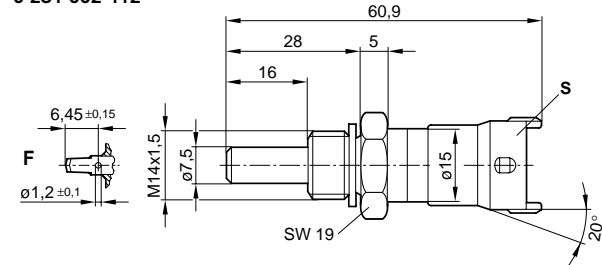

Technical data

Part number		0 280 130 026	0 280 130 093	0 281 002 170	0 281 002 209	0 281 002 412
Application/medium		Water	Water	Oil/Water	Water	Water
Measuring range	°C	-40...+130	-40...+130	-40...+150	-40...+130	-40...+130
Tolerance at	+20 °C °C	1.2	1.2	±1.5	±1.5	±1.5
	+100 °C °C	3.4	3.4	±0.8	±0.8	±0.8
Nominal resistance at 20 °C	kΩ	2.5 ±5 %	2.5 ±5 %	2.5 ±6 %	2.5 ±6 %	2.5 ±6 %
Electrical resistance at	-10 °C kΩ	8.26...10.56	8.727...10.067	8.244...10.661	8.244...10.661	8.244...10.661
	+20 °C kΩ	2.28...2.72	2.375...2.625	2.262...2.760	2.262...2.760	2.262...2.760
	+80 °C kΩ	0.290...0.364	-	0.304...0.342	0.304...0.342	0.304...0.342
Nominal voltage	V	≤ 5	≤ 5	≤ 5	≤ 5	≤ 5
Measured current, max.	mA	1	1	1	1	1
Thermal time constant	s	44	44	15	15	15
Max. power loss at ΔT ≈ 1K and stationary air 23 °C	m · s ⁻²	100	≤ 300	≤ 300	≤ 300	≤ 300
Degree of protection ¹⁾			IP 54A	IP 64K	IP 64K	IP 64K IP 64K
Thread		M 12 x 1.5	M 12 x 1.5	M 12 x 1.5	M 12 x 1.5	M 14 x 1.5
Corrosion-tested as per		DIN 50 018	DIN 50 018	DIN 50 021 ²⁾	DIN 50 021 ²⁾	DIN 50 021 ²⁾
Plugs		Jetronic, Tin-plated pins	Compact 1, Tin-plated pins	Compact 1, Gold-plated pins	Compact 1.1, Tin-plated pins	Compact 1.1, Tin-plated pins
Tightening torque	Nm	25	18	18	25	20

¹⁾ With single-conductor sealing

²⁾ Saline fog 384 h

Accessories

For 0 280 130 026

Designation	Part number
Connector	1 237 000 036

For 0 280 130 093, 0 281 002 170

Designation	For cable cross-section	Part number
Plug housing	-	1 928 403 137
Contact pins	0.5 ... 1.0 mm ²	1 987 280 103
	1.5 ... 2.5 mm ²	1 987 280 105
Individual gaskets	0.5 ... 1.0 mm ²	1 987 280 106
	1.5 ... 2.5 mm ²	1 987 280 107

For 0 281 002 209, 0 281 002 412

Designation	For cable cross-section	Part number
Plug housing	-	1 928 403 874
Contact pins	0.5 ... 1.0 mm ²	1 928 498 060
	1.5 ... 2.5 mm ²	1 928 498 061
Individual gaskets	0.5 ... 1.0 mm ²	1 928 300 599
	1.5 ... 2.5 mm ²	1 928 300 600